

PRINCIPLE OF OPERATION

The switching action is achieved through the use of an internal magnet within the float and its interaction with the switch mechanism. As the liquid level changes inside the tank, the float moves. Its magnetic field opens or closes each reed switch inside the stem to complete an electrical circuit.

Option LC800-2 Installation Instructions

CAUTION: Refer to instructions before operating or servicing switch.

Construction: 316 Stainless Steel stem, 2" 316 ss float, 2" NPT bushing.

Switch set-point distances are measured from the underside of the 2" NPT bushing to the centre of the float at the level where the switch is activated. Switch set-point distances are not field adjustable. They are factory-set as specified on the purchase order. The contact arrangement may be changed from normally open (NO) to normally closed (NC) and vice versa. Turn over the float and return the stop collars to their original positions. If the contact arrangement is altered, use an ohmmeter to test that the switch operates correctly. Screw the float switch into the 2" NPT opening on the top of the tank. The conductors are colour coded to identify each switch. The switch must be connected in series with a load.

DO NOT CONNECT THE SWITCH DIRECTLY ACROSS THE POWER SUPPLY.

The voltage / current product must not exceed the power rating.

Electrical Specifications

Maximum Switching Voltage VOLTS DC/AC	240
Maximum Switching Current AMPS DC/AC	1.0
Maximum Switching Power WATTS DC/AC	100
Max. Operating Temperature	90°C 194°F



Class I Division 1 and 2, Groups A,B,C,D,T5

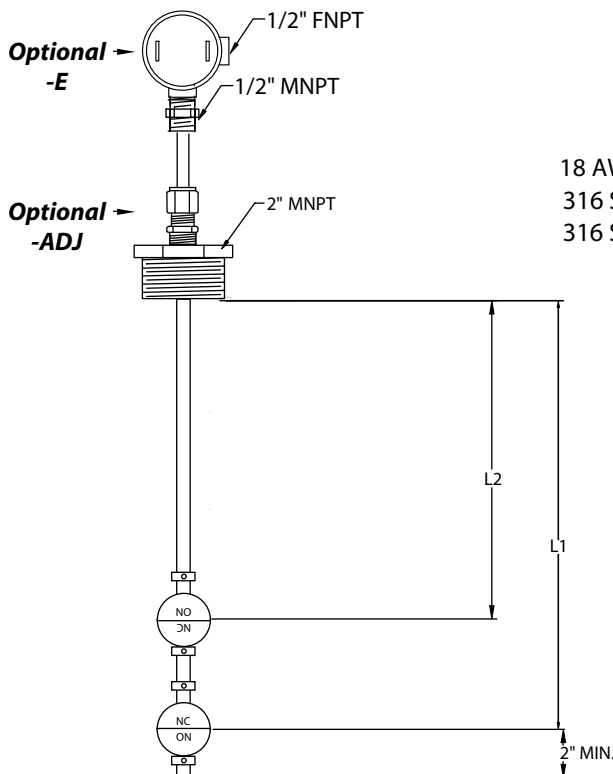

18 AWG Type TR-64
316 SS FLOAT 2" DIA
316 SS STEM 1/2" O.D.

KEY FEATURES

- Probe Lengths Up to 12'
- Up to 5 Switch Positions
- 100 VA Switch (Standard)
- Adjustable Model Options

